

马达 Motor:Brushless DC,auto restart
Impedance & polarity protected

风叶外壳 Impeller & Frame:Glassfiber reinforced thermoplastic
PBT,UL94V-0

绝缘 Insulation Resistance:Min.10M at DC 500V

耐压 Dielectric Strength:500VAC/1 sec. Max.leakage
500 micro amp.

温度范围 Permissible Temp.Range:Ball bearing -20 °C ~ +75 °C
Sleeve bearing -10 °C ~ +50 °C

安规认证 Safety:UL>CUL>CE

寿命 Life Expectancy at 40 :Ball bearing 50000 hours
Sleeve bearing 30000 hours



BRUSHLESS FAN
50 × 50 × 15mm

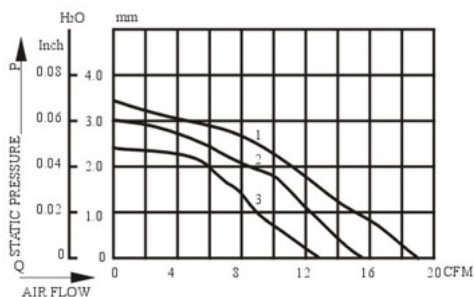
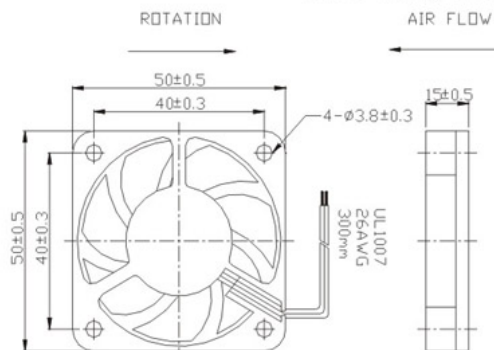

Model (型号)	Rated Voltage (VDC) (额定电压)	Startup Voltage (VDC) (启动电压)	Current Amp (A) (电流)	Speed (rpm) (转速)	Air Flow (CFM) (风量)	Static Pressure (mm-H ₂ O) (风压)	Noise Level (dB-A) (噪音)	Weight (g) (重量)
YM1205PHS1	12.0	5.0	0.20	6300	18.90	3.30	26.0	29.0
YM1205PHB1								
YM1205PHS2	12.0	5.0	0.15	5000	15.00	2.97	23.4	29.0
YM1205PHB2								
YM1205PHS3	12.0	5.0	0.10	4500	13.50	2.64	20.8	29.0
YM1205PHB3								
YM2405PHS1	24.0	10.0	0.12	6300	11.20	3.30	26.0	29.0
YM2405PHB1								
YM2405PHS2	24.0	10.0	0.08	5000	10.08	2.97	23.4	29.0
YM2405PHB2								
YM2405PHS3	24.0	10.0	0.06	4500	8.96	2.64	20.8	29.0
YM2405PHB3								